



# GlideScope® Video Laryngoscopes

## Operations & Maintenance Manual

**GlideScope**  
verathon



# GlideScope

# Video Laryngoscopes

## Operations & Maintenance Manual

Effective: July 14, 2023

Caution: Federal (United States) law restricts this device to sale by or on the order of a physician.

# Contact Information

To obtain additional information regarding your GlideScope system, please contact Verathon Customer Care or visit [verathon.com/service-and-support](https://www.verathon.com/service-and-support).

## Verathon Inc.

20001 North Creek Parkway  
Bothell, WA 98011 U.S.A.  
Tel: +1 800 331 2313 (US and Canada only)  
Tel: +1 425 867 1348  
Fax: +1 425 883 2896  
[verathon.com](https://www.verathon.com)



## Verathon Medical (Canada) ULC

2227 Douglas Road  
Burnaby, BC V5C 5A9  
Canada  
Tel: +1 604 439 3009  
Fax: +1 604 439 3039

**EC REP**



## Verathon Medical (Europe) B.V.

Willem Fenengastraat 13  
1096 BL Amsterdam  
The Netherlands  
Tel: +31 (0) 20 210 30 91  
Fax : +31 (0) 20 210 30 92

## Verathon Medical (Australia) Pty Limited

Unit 9, 39 Herbert Street  
St Leonards NSW 2065  
Australia  
Within Australia: 1800 613 603 Tel / 1800 657 970 Fax  
International: +61 2 9431 2000 Tel /  
+61 2 9475 1201 Fax

**CH REP**

## MDSS CH GmbH

Laurenzenvorstadt 61  
5000 Aarau  
Switzerland



CH

## Anandic Medical Systems AG

Stadtweg 24  
8245 Feuerthalen  
Switzerland

**UK REP**

## MDSS-UK RP Ltd.

6 Wilmslow Road, Rusholme  
Manchester M14 5TP  
United Kingdom  
Tel: +44 (0)7898 375115



Copyright © 2023 by Verathon Inc. All rights reserved. No part of this manual may be copied or transmitted by any method without the express written consent of Verathon Inc.

GlideScope, the GlideScope symbol, GVL, Core, Spectrum, Reveal, Verathon, and the Verathon Torch symbol are trademarks of Verathon Inc. All other brand and product names are trademarks or registered trademarks of their respective owners.

Not all Verathon Inc. products shown or described in this manual are available for commercial sale in all countries.

Information in this manual may change at any time without notice. For the most up-to-date information, see the documentation available at [verathon.com/service-and-support](https://www.verathon.com/service-and-support).

# Table of Contents

---

<b>IMPORTANT INFORMATION .....</b>	<b>1</b>
Product Information .....	1
Kasutusotstarve.....	1
Essential Performance .....	1
Environments of Intended Use .....	1
Ettekirjutuse avaldus .....	1
Notice to All Users .....	1
Hoiatused ja ettevaatusabinõud .....	2
<b>BLADES, BATONS, &amp; CABLES.....</b>	<b>8</b>
Video Laryngoscopes.....	8
Video Cables .....	12
Compatibility.....	13
<b>COMPONENTS.....</b>	<b>15</b>
Video Laryngoscopes.....	15
Batons.....	16
Video Cables .....	16
<b>SETTING UP.....</b>	<b>17</b>
<i>Procedure 1. Perform Initial Inspection.....</i>	<i>17</i>
<i>Procedure 2. Attach the Video Cable to the Monitor.....</i>	<i>18</i>
<i>Procedure 3. Attach the Scope to the Video Cable.....</i>	<i>19</i>
<i>Procedure 4. Perform a Functional Check.....</i>	<i>20</i>
<b>USING THE DEVICE.....</b>	<b>21</b>
<i>Procedure 1. Prepare the Scope .....</i>	<i>21</i>
<i>Procedure 2. Intubate the Patient .....</i>	<i>23</i>
<i>Procedure 3. Prepare a Component for Cleaning.....</i>	<i>24</i>

<b>REPROCESSING</b>	<b>25</b>
<b>HOOLDUS JA OHUTUS</b>	<b>26</b>
Korralised kontrollid	26
Elueerimise sobivus	26
Seadme parandamine	26
Seadme kõrvaldamine	26
<b>LIMITED WARRANTY</b>	<b>27</b>
<b>PRODUCT SPECIFICATIONS</b>	<b>29</b>
Component Specifications	29
Electromagnetic Compatibility	48
<b>GLOSSARY</b>	<b>51</b>

# Important Information

---

This manual details how to use video laryngoscopes that are compatible with the GlideScope Video Monitor (GVM), GlideScope Core monitors, and the GlideScope Go 2 monitor.

## Product Information

GlideScope video laryngoscopes combine innovative designs in reusable and single-use options to enable intubations across a wide range of patient types, weights, and clinical settings. GlideScope video laryngoscopes are designed to deliver high-resolution airway views when used with compatible GlideScope video monitors.

For manuals specific to your video monitor, please visit [verathon.com/service-and-support](http://verathon.com/service-and-support), or contact Verathon Customer Care. For information on monitor, cable, and scope compatibility, see [Compatibility](#) on page 13.

## Kasutusotstarve

Need komponendid on mõeldud kasutamiseks kvalifitseeritud töötajatele, et saada meditsiiniliste protseduuride jaoks selge ja takistusteta ülevaade hingamisteest ja häälekurdudest.

## Essential Performance

*Essential performance* is the system performance necessary to achieve freedom from unacceptable risk. When connected with an appropriate monitor, the essential performance of these components is to provide a clear view of the vocal cords.

## Environments of Intended Use

GlideScope systems are intended to be used in professional healthcare environments such as hospitals.

## Ettekirjutuse avaldus

Ettevaatust: Föderaalseadused (Ameerika Ühendriigid) lubavad seda seadet müüa ainult arstil või arsti ettekirjutusel.

Neid komponente võivad kasutada ainult koolitatud ja arsti volitatud isikud või tervishoiuteenuse osutajad, kes on läbinud patsiendihooldusteenuseid pakkuva asutuse koolituse ja saanud selleks volituse.

## Notice to All Users

Verathon recommends that all users read this manual before using these components. Failure to do so may result in injury to the patient, may compromise the performance of the system, and may void the system warranty. Verathon recommends that new GlideScope users:

- Obtain instruction from a qualified individual
- Practice using the system on a mannequin before clinical use
- Acquire clinical experience on patients without airway abnormalities

# Hoiatused ja ettevaatusabinõud

*Hoiatused* viitavad, et seadme kasutamine või väärkasutamine võib tekitada vigastusi, surma või muid tõsiseid kõrvaltoimeid. *Ettevaatusabinõud* viitavad sellele, et seadme kasutamine või valesti kasutamine võib tekitada probleeme, nt talitlushäireid, rikkeid või seadme kahjustusi. Pöörake kogu kasutusjuhendis tähelepanu jaotistele pealkirjaga „Oluline“, mis sisaldavad järgmiste ettevaatusabinõude meeldetuletusi või kokkuvõtteid, kuna need kehtivad konkreetse komponendi või kasutusolukorra puhul. Pöörake tähelepanu järgmistele hoiatustele ja ettevaatusabinõudele.

## Hoiatused: Kasutamine



### HOIATUS

Enne iga kasutuskorda veenduge, et seade töötaks õigesti ja sellel ei oleks kahjustusi. Ärge kasutage seda toodet, kui seade näib kahjustatud olevat. Pöörduge hooldustööde tegemiseks kvalifitseeritud töötajate poole.

Veenduge alati, et alternatiivsed hingamisteede juhtimise meetodid ja seadmed oleksid käepärast.

Teavitage Verathon'i klienditeenindust kõigist oletatavatest vigadest. Vaadake kontaktteavet veebilehelt [verathon.com/service-and-support](http://verathon.com/service-and-support).



### HOIATUS

Kaasaskantavaid raadiosideseadmeid (sh välisseadmeid, nt antennikaableid ja välisantenne) ei tohi kasutada kuni 30 cm (12 tolli) kaugusel süsteemi mistahes osast, k.a kaablitest, mille Verathon on määranud või mida Verathon pakub kasutamiseks selle süsteemiga. Kui vahekaugust ei hoita, võib süsteemi jõudlus halveneda ja kujutise kuvamine häiruda.



### HOIATUS

Kui juhite endotrahheaalтору videolarüngoskoobi distaalotsani, veenduge, et vaataksite patsiendi suhu, aga mitte ekraanile. Ekraanile vaatamise korral võite vigastada nt mandleid või pehmet suulage.



### HOIATUS

Ärge pange videopulka hoidikusse, kui mõni komponent on saastunud.





### HOIATUS

Videolarüngoskoobi kaamerat ümbritsev piirkond võib patsiendiga kokku puutuda ja selle temperatuur võib tavapärase töö käigus ületada temperatuuri 41 °C (106 °F). Patsiendi kokkupuutumine selle laba piirkonnaga on intubeerimisel ebatõenäoline, sest see takistaks kaamera vaadet. Ärge hoidke seda laba piirkonda patsiendiga kontaktis kauem kui 1 minut; võimalik on tekitada termokahjustusi, näiteks põletada limaskesta.

## Hoiatused: Töötlemine



### HOIATUS

Korduskasutatavad videolarüngoskoobid ja videokaablid tarnitakse mittesteriilsena ning need tuleb enne esimest kasutamist puhastada ja desinfitseerida.



### HOIATUS

Puhastamine on ülioluline, et tagada komponendi valmisolek desinfitseerimiseks või steriliseerimiseks. Kui seadet ei puhastata korralikult, võib see pärast desinfitseerimis- või steriliseerimisprotseduuri olla endiselt saastunud.

Puhastamisel veenduge, et seadme pinnalt saaksid eemaldatud kõik võõrkehad. See võimaldab valitud desinfitseerimismeetodi toimeainetel mõjuda kõikidele pindadele.



### HOIATUS

Seda toodet tohib puhastada, desinfitseerida või steriliseerida ainult GlideScope'i ja GlideRite'i toodete töötlemisjuhendis (osa number 0900-5032) esitatud heakskiidetud menetlustega. Verathon soovib loetletud puhastus-, desinfitseerimis- ja steriliseerimismeetodeid tõhususe või komponentide materjalidega sobivuse alusel.



### HOIATUS

Puhastus-, desinfitseerimis- ja steriliseerimistoodete saadavus on riigiti erinev ja Verathon ei suuda igal turul saadavaid tooteid katsetada. Küsige lisateavet Verathon klienditeeninduselt. Vaadake kontaktteavet veebilehelt [verathon.com/service-and-support](http://verathon.com/service-and-support).



### HOIATUS

Korduskasutatav videolarüngoskoop Titanium on hingamisteega kokku puutuv poolkriitiline seade. Seda tuleb pärast iga kasutuskorda põhjalikult puhastada ja kõrgetasemeliselt desinfitseerida.



### HOIATUS

Kuna toode võib saastuda inimese vere või kehavedelikega, mille kaudu võivad levida patogeenid, peavad kõik puhastusseadmed olema kooskõlas Ameerika Ühendriikide standardiga OSHA Standard 29 CFR 1910.1030 „Vere kaudu levivad patogeenid“ või võrdväärse standardiga.



### HOIATUS

Ärge kasutage, töödelge ega steriliseerige ühekordselt kasutatavaid komponente korduvalt. Korduv kasutamine, töötlemine või steriliseerimine võib komponendi või GlideScope'i süsteemi saastada.



### HOIATUS

Teavet soovitatavate töötlemislahuste käsitlemise ja kõrvaldamise kohta vaadake lahuse tootja juhistest.



### HOIATUS

Enne iga komponendi desinfitseerimist või steriliseerimist veenduge, et see oleks täiesti puhas. Vastasel juhul ei pruugi desinfitseerimis- või steriliseerimisprotseduur kogu saastet eemaldada. See suurendab nakkusohtu.



### HOIATUS

Ärge kasutage, töödelge ega steriliseerige ühekordselt kasutatavaid komponente korduvalt. Korduval kasutamisel, töötlemisel või steriliseerimisel võib tekkida seadme saastumise oht.

## Hoiatused: Tooteohutus



### HOIATUS

Elektrilöögiohu vähendamiseks kasutage ainult Verathon'i soovitatud tarvikuid ja välisseadmeid.



### HOIATUS

Elektrilöögioht. Ärge püüdke süsteemi komponente avada. Avamine võib kasutajat raskelt vigastada või kahjustada seadet ja tühistada garantii. Kõikide hooldusvajaduste korral võtke ühendust Verathon'i klienditeenindusega.



### HOIATUS

Muude kui Verathoni määratud või tarnitud tarvikute ja kaablite kasutamine võib põhjustada süsteemis elektromagnetilisi rikkeid, sh suurendada kiirgumist või vähendada häirekindlust. See võib põhjustada seadme talitlushäireid, protseduuri viivitusi või mõlemat.



### HOIATUS

Seadme muutmine ei ole lubatud.

## Ettevaatusabinõud



### ETTEVAATUST

Süsteem sisaldab elektroonilisi osi, mida ultraheliseade ja automaatne pesur võivad kahjustada. Ärge kasutage toote puhastamiseks ultraheliseadet ega automaatset pesurit, mida Verathon ei ole heaks kiitnud.



### ETTEVAATUST

Ärge kasutage videolarüngoskoopide puhastamisel metallharju, abrasiivseid harju, küürimispadjakesi ega jäiku tööriistu. Need kriimustavad seadme või kaamerat ja valgusallikat kaitsva akna pinda, mis võib seadet püsivalt kahjustada.



### ETTEVAATUST

Süsteemidel Video Baton võib kasutada pleegitusvahendit, kuid pöörake erilist tähelepanu roostevabast terasest osadele, kuna pleegitusvahend võib roostevaba terast söövitada.



### ETTEVAATUST

Seadme püsiva kahjustamise oht. Toode on tundlik kuumuse suhtes, mis tekitab elektroonikale kahjustusi. Vältige süsteemi sattumist üle 60 °C (140 °F) temperatuuriga keskkonda ja ärge kasutage autoklaave ega pastöriseerimisseadmeid. Selliste meetodite kasutamine süsteemi puhastamiseks, desinfitseerimiseks või steriliseerimiseks tekitab seadmele püsivaid kahjustusi ja muudab garantii kehtetuks. Heakskiidetud puhastustoimingute ja -toodete loendit vaadake GlideScope'i ja GlideRite'i toodete töötlemisjuhendist (osa number 0900-5032).



### ETTEVAATUST

Ärge kasutage ühekordselt kasutatavat videolarüngoskoopi sisaldava pakendi avamiseks nuga ega muud teravat eset ning ärge kasutage komponente, kui nende pakendid on kahjustatud.



## ETTEVAATUST

Ainult Euroopa Liidu puhul: Kui selle toote kasutamise ajal juhtub tõsine vahejuhtum, peate viivitamatult teavitama ettevõtet Verathon (või selle autoriseeritud esindajat), selle liikmesriigi pädevat asutust, kus juhtum aset leidis, või mõlemat.



## ETTEVAATUST

Elektriliste meditsiiniseadmete kasutamisel on vaja elektromagnetilise ühilduvuse (EMC) tagamiseks rakendada erilisi ettevaatusabinõusid ning need seadmed tuleb paigaldada ja neid tuleb kasutada selles juhendis esitatud juhiste järgi. Vaadake lisateavet elektromagnetilise ühilduvuse jaotisest.

Vältige süsteemi GlideScope kasutamist teiste seadmete kõrval või nendega virmastatuna. Kui külgnev või virmastatud kasutamine on vajalik, jälgige süsteemi, et kontrollida selle normaalset talitlust konfiguratsioonis, milles seda kasutatakse.

Seade võib kiirata raadiosagedusenergiat ja väga tõenäoliselt ei tekita see kahjulikke raadiohäireid teistele läheduses asuvatele seadmetele. Ei ole tagatud, et konkreetses konfiguratsioonis häireid ei esine. Häirete esinemise ilminguks võib muu hulgas olla selle seadme või teiste seadmete talitluse halvenemine, kui seadmeid kasutatakse samal ajal. Kui see juhtub, proovige häired kõrvaldada järgmiste meetmetega.

- Lülitage läheduses asuvaid seadmeid sisse ja välja, et teha kindlaks häire allikas.
- Muutke selle seadme või muude seadmete suunda või asukohta.
- Suurendage seadmete vahekaugust.
- Ühendage seade sellise vooluringi pistikupessa, millesse ei ole ühendatud teisi läheduses asuvaid seadmeid.
- Kõrvaldage elektromagnethäire (EMI) või vähendage seda tehniliste lahendustega (nt varjestamisega).
- Ostke meditsiiniseadmed, mis vastavad standardi IEC 60601-1-2 EMC nõuetele.

Pidage meeles, et kaasaskantavad ja mobiilsed raadiosideseadmed (mobiiltelefonid jne) võivad mõjutada elektrilisi meditsiiniseadmeid. Rakendage töö ajal vajalikke ettevaatusabinõusid.

## Ettevaatusabinõud: Töötlemine



### ETTEVAATUST

Ärge viige süsteemi GlideScope komponente nende hoiukohtadesse tagasi enne, kui need on põhjalikult puhastatud ja vajaduse korral desinfitseeritud või steriliseeritud. Saastunud komponentide viimine hoiukohtadesse suurendab nakkusohtu.



### ETTEVAATUST

Soovitusi töötlemisvahendi käsitlemise ja kõrvaldamise kohta vaadake töötlemisvahendi tootja juhendist.



### ETTEVAATUST

GlideScope'i süsteemide korduskasutatavaid komponente ei tarnita steriilsetes tingimustes. Puhastage ja vajaduse korral desinfitseerige või steriliseerige need enne esimest kasutamist. Vastasel korral suureneb nakkusoht.



### ETTEVAATUST

Ärge kasutage kaamerate või ekraanide puhastamisel abrasiivseid harju, patju ega tööriistu. Need esemed võivad kriimustada läbipaistvaid plastosi ja seadet jäädavalt kahjustada.



### ETTEVAATUST

Ärge kasutage Verathoni toote puhastamiseks ultraheliseadet ega automaatset pesurit, välja arvatud juhul, kui kasutate puhastamiseks toodetega ühilduvaid süsteeme, mille on Verathon heaks kiitnud. Verathoni muude toodete puhastamine ultraheliseadme või automaatse pesuri või ühilduvate automaatsete puhastussüsteemide nimekirjas loetlemata pesusüsteemidega võib toodet kahjustada.



### ETTEVAATUST

Seadme püsiva kahjustamise oht. Toode on tundlik kuumuse suhtes, mis tekitab elektroonikale kahjustusi. Vältige süsteemi sattumist üle 60 °C (140 °F) temperatuuriga keskkonda ja ärge kasutage autoklaave ega pastöriseerimisseadmeid. Selliste meetodite kasutamine süsteemi puhastamiseks, desinfitseerimiseks või steriliseerimiseks tekitab seadmele püsivaid kahjustusi ja muudab garantii kehtetuks. Heakskiidetud puhastustoimingute ja -toodete loendit vaadake GlideScope'i ja GlideRite'i toodete töötlemisjuhendist (osa number 0900-5032).

# Blades, Batons, & Cables

GlideScope video laryngoscopes are available in the following formats:

- GlideScope Titanium Reusable video laryngoscopes
- GlideScope Spectrum Single-Use video laryngoscopes
- GlideScope Spectrum QC Single-Use video laryngoscopes
- GlideScope AVL Video Batons for use with Single-Use GVL Stats (blades)
- GlideScope Video Baton 2.0 for use with Single-Use GVL Stats (blades)
- GlideScope Video Baton QC for use with Single-Use GVL Stats (blades)

*Note: For information on approximate weight ranges for reusable video laryngoscopes, single-use video laryngoscopes, and GVL Stats, see the procedure [Prepare the Scope](#) on page 21.*

## Video Laryngoscopes

### Titanium Reusable Video Laryngoscopes

GlideScope Titanium reusable video laryngoscopes are made from durable/lightweight titanium, which enable low-profile blade designs for optimized maneuverability and working space. The video laryngoscope is connected to the video monitor via a reusable video cable. Titanium reusable video laryngoscopes are available in a uniquely angulated LoPro style, and in Mac style as well.

*Figure 1. GlideScope Titanium Reusable Video Laryngoscopes*





# Spectrum Single-Use Video Laryngoscopes

The Spectrum and Spectrum QC single-use video laryngoscopes are fully disposable video laryngoscopes that integrate the latest advancements in lighting technology to optimize image brightness and clarity throughout the intubation process. These single-use video laryngoscopes are connected to cart-based video monitors via a Smart Cable or QuickConnect cable and are available in uniquely angulated LoPro (Spectrum) and Hyperangulated (Spectrum QC) styles, and in Miller and Mac styles as well.

Spectrum LoPro S3, LoPro S4, Hyperangle S3, Hyperangle S4, DirectView MAC S3, DirectView MAC S4 are compatible with the Dynamic Light Control feature available on GlideScope Core monitors.

Table 1. *GlideScope Monitor and Connector Compatibility*

CONNECTOR TYPE	COMPATIBILITY			
	GlideScope Core	GlideScope Video Monitor	GlideScope Go	GlideScope Go 2
 QuickConnect (Spectrum QC)	●			●
 HDMI (Spectrum Single-Use)	●	●	●	

Note: For information on which cables to use when connecting these video laryngoscopes to the GlideScope Core Monitor or the GlideScope Video Monitor, refer to the [Compatibility](#) section.

Figure 2. Spectrum Single-Use Video Laryngoscopes



Figure 3. Spectrum QC Single-Use Video Laryngoscopes





## Video Batons & Stats

Reusable video batons combine a high-resolution, full-color digital camera with an integrated LED light source and Reveal anti-fog feature. Video batons are connected to cart-based video monitors via a permanently-integrated video cable (AVL Video Batons), or a separate Smart Cable (Video Baton 2.0). Video batons are available with a choice of two sizes and are designed to be used with single-use GVL Stats. GVL Stats are offered in a comprehensive range of sizes, allowing clinicians to meet the particular requirements of a wide range of patients.

Each GVL Stat size is designed for a specific video baton size, as shown in Table 2.

Table 2. AVL Video Baton and GVL Stat Compatibility

VIDEO BATON SIZE	COMPATIBLE GVL STAT SIZES					
	0	1	2	2.5	3	4
1-2	●	●	●	●		
3-4 (Large)					●	●

Figure 4. Video Batons



AVL Video Baton 1-2



AVL Video Baton 3-4



Video Baton 2.0 Large (3-4)



GlideScope Video Baton QC Large

Figure 5. Single-Use Stats

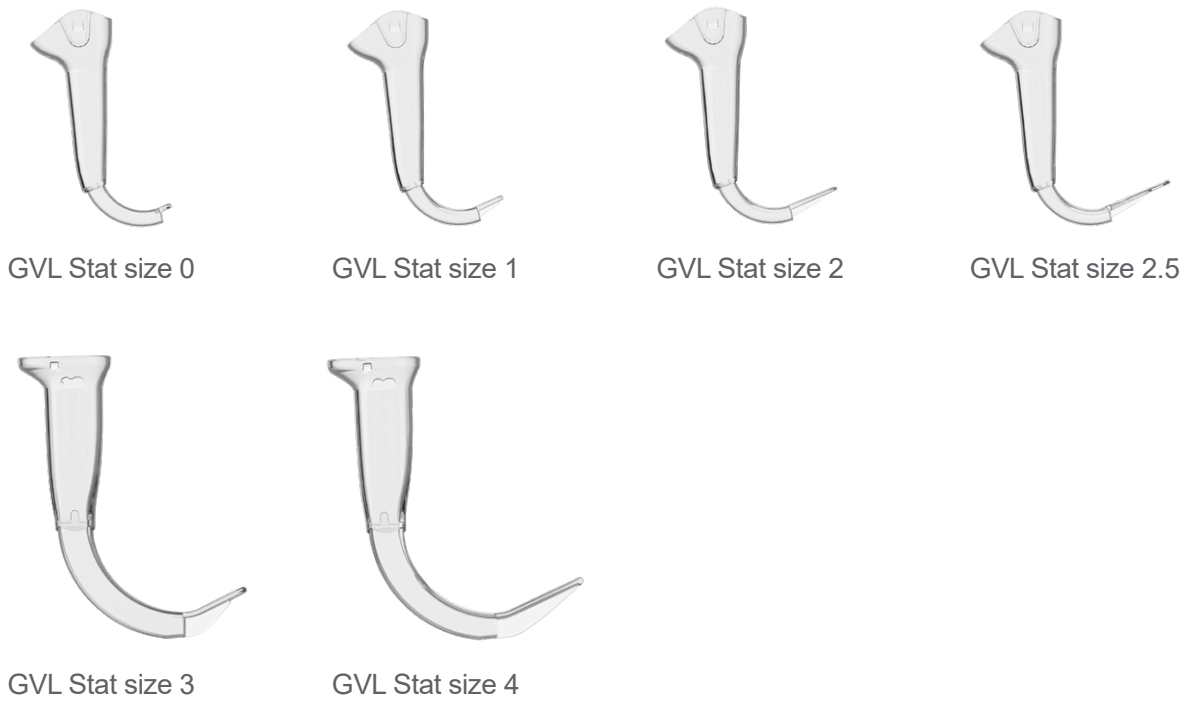

## Video Cables

The video laryngoscopes in this manual require a video cable to connect to cart-based monitors. In this document, unless otherwise noted, the term *video cable* describes both Smart Cables and video cables. For information on compatibility between video laryngoscopes, batons, cables, and monitors, see [Compatibility](#) on page 13.

Figure 6. GlideScope Cables\*

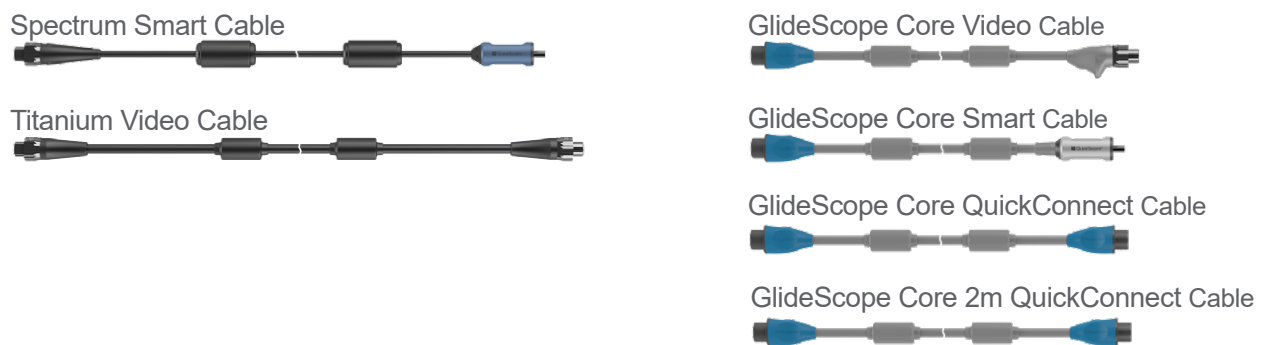

\* Cables have been shortened for illustrative purposes. For cable dimensions, see [Component Specifications](#) on page 29

# Compatibility

GlideScope components may be compatible with other GlideScope product lines. The following tables show the component compatibility between monitors, video cables, and scopes. For information specific to your monitor, see [verathon.com/service-and-support](http://verathon.com/service-and-support), or contact Verathon Customer Care.

Table 3. *GlideScope Core Compatibility*











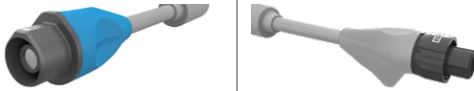

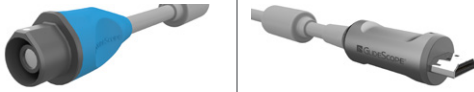
MONITOR	VIDEO CABLE		SCOPE
	To Monitor	To Scope	
<p>GlideScope Core</p> 	<p>GlideScope Core Video Cable</p> 		<p>Titanium reusable blades</p> 
	<p>GlideScope Core Smart Cable</p> 		<p>Video Baton 2.0 Large (3-4)</p>  <p>Spectrum Single-Use blades</p> 
	<p>GlideScope Core QuickConnect cable and Core 2m QuickConnect cable</p> 		<p>Video Baton QC Large</p>  <p>Spectrum QC Single-Use blades</p> 

Table 4. GlideScope Video Monitor (GVM) Compatibility

MONITOR	VIDEO CABLE		SCOPE
	To Monitor	To Scope	
<p>GlideScope Video Monitor</p> 	<p>Titanium Video Cable</p> 		<p>Titanium Reusable</p> 
	<p>Spectrum Smart Cable</p> 		<p>Video Baton 2.0 Large (3-4)</p>  <p>Spectrum Single-Use blades</p> 
	 <p>Video Baton 3-4</p>		
	 <p>Video Baton 1-2</p>		

Table 5. GlideScope Go 2 Compatibility

MONITOR	VIDEO CABLE		SCOPE
	To Monitor	To Scope	
	<p>No cable. Direct connection.</p> 		<p>Video Baton QC Large</p>  <p>Spectrum QC Single-Use blades</p> 

# Components

## Video Laryngoscopes

Figure 7. Titanium & Spectrum Video Laryngoscope Components

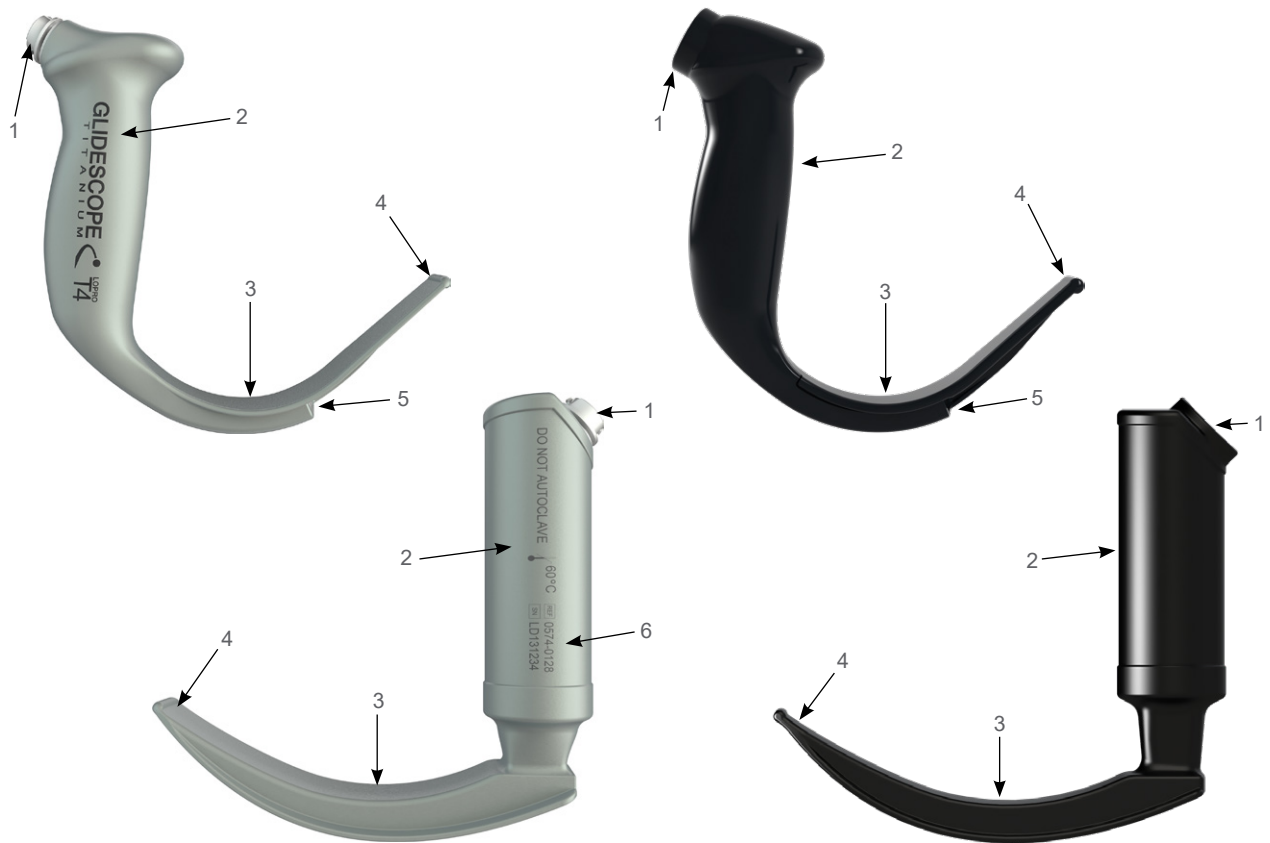

Table 6. Video Laryngoscope Components

FIGURE KEY	COMPONENT	NOTES
1	Connector	—
2	Handle	—
3	Blade	Various styles, sizes, and construction.
4	Distal tip	—
5	Camera and light	High-resolution, full-color camera with integrated LED light source
6	Product number and serial number	On the left side of the handle of reusable video laryngoscopes.

# Batons

Figure 8. Video Baton Components

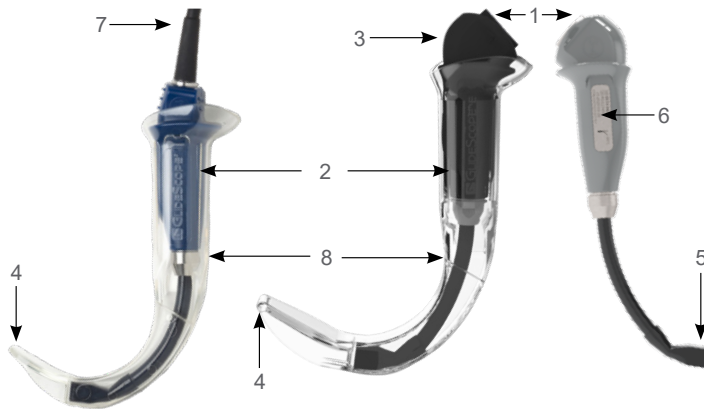

Table 7. Video Baton Components

FIGURE KEY	COMPONENT	NOTES
1	Connector	—
2	Handle	—
3	Baton	Reusable camera compatible with Single-Use GVL Stats.
4	Distal tip	—
5	Camera and light	High-resolution, full-color camera with integrated LED light source.
6	Label	Product number and serial number. Located the right side of the video baton handle.
7	Video cable	—
8	Single-Use GVL Stat	—

# Video Cables

Figure 9. Video Cable Components



Table 8. Video Cable Components

FIGURE KEY	COMPONENT	NOTES
1	Connector	Cables are available with several connector configurations. For more information, see <a href="#">Compatibility</a> on page 13.
2	Cable*	—
3	Electronics	Smart cables only.

\* Cable have been shortened for illustrative purposes.

# Setting Up

---



Please read the [Hoiatused ja ettevaatusabinõud](#) section before performing the following tasks.

This chapter contains information on connecting a video monitor, video cable, and scope. The video cable attaches the scope to the monitor, supplying power to the component and transmitting video data from the scope's camera to the monitor.

Before you can use the system for the first time, you must inspect the components, set up the system, and perform a functional test as recommended by Verathon. Complete the following procedures:

1. **Perform Initial Inspection**—Inspect components for any obvious physical damage that may have occurred during shipment.
2. **Attach the Video Cable to the Monitor**—Attach the video cable that provides power to the scope, and transmits the video signal to the monitor.
3. **Attach the Scope to the Video Cable**—Attach the scope that houses the camera and light.
4. **Perform a Functional Check**—Before you use the device for the first time, perform a functional check to ensure that the system is working properly.

---

## Procedure 1. Perform Initial Inspection

---

When you receive a component, Verathon recommends that an operator familiar with it perform a full visual inspection for any obvious physical damage that may have occurred during shipment.

1. Verify that you have received the appropriate components for your system by referring to the packing list included with the system.
2. Inspect the components for damage.
3. If any of the components are missing or damaged, notify the carrier and Verathon Customer Care or your local representative. For contact information, visit [verathon.com/service-and-support](http://verathon.com/service-and-support).

---

## Procedure 2. Attach the Video Cable to the Monitor

---

This procedure provides basic instruction on connecting video cables to a monitor. For detailed information about compatible monitors, see [Compatibility](#) on page 13. For information on a specific monitor, please refer to its Operations & Maintenance Manual, or contact Verathon Customer Care.

### Option 1. GlideScope Video Monitor

---

1. Ensure the video monitor is turned off prior to connecting or disconnecting the video cable or Smart Cable.
2. Align the arrow on the video cable and the arrow on the video cable port, and then insert the cable into the port. You will hear a click when the cable is successfully connected.

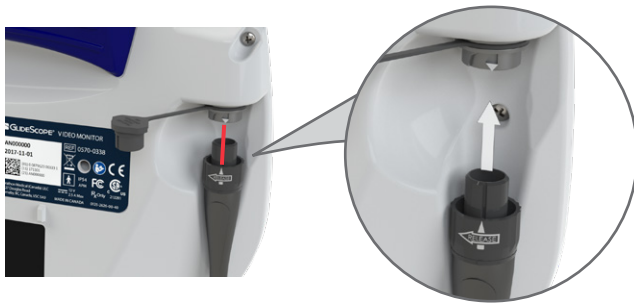

3. To disconnect the video cable from the monitor, rotate the connector ring in the direction of the release arrow, and then remove the connector from the port.



### Option 2. Core Video Monitor

---

1. Align the dot on the cable connector to the dot on one of the monitor's video connectors, and then fully insert the cable. The connector attaches to the monitor with magnets.

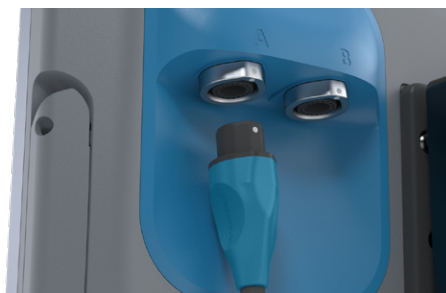

2. To disconnect the video cable, hold the cable connector in one hand and support the monitor with the other, and then pull. The cable disconnects from the monitor.



### Option 3. Go 2 Video Monitor

---

1. Align the mark on the monitor with the mark on the baton or single-use blade, and then insert the blade/baton connector fully into the connector port on the blade or baton.



2. To disconnect the scope from the monitor, hold the scope in one hand the monitor with the other, and then pull. The scope disconnects from the monitor.

---

### Procedure 3. Attach the Scope to the Video Cable

---

#### Option 1. Video Cables for Reusable Video Laryngoscopes

---

1. Bring into line the alignment marks on the video cable and scope connectors, and then fully insert the video cable into the scope connector port. You will hear a click when the cable is successfully connected.

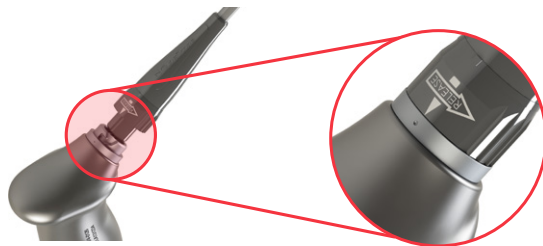

2. To disconnect the scope from the video cable, hold the scope in one hand, twist the cable's locking collar in the direction specified by the arrow on the collar, and then pull. The scope disconnects from the cable.

#### Option 2. Smart and QuickConnect Cables

---

It is recommended that you leave single-use accessories in their packaging while connecting the cable and that you do not remove it until you are ready to perform the procedure. This helps ensure that the blade remains as clean as possible until you are ready to use it.

1. Bring into line the alignment marks on the video cable and scope connectors, and then fully insert the video cable into the scope connector port.

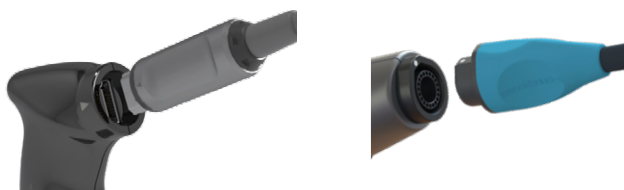

2. To disconnect the scope from the video cable, hold the cable connector in one hand and the scope's body in the other, and then pull. The video component disconnects from the cable.

---

## Procedure 4. Perform a Functional Check

---

Before you use the device for the first time, perform the following functional check to ensure that the system is working properly. Please contact your local Verathon representative or Verathon Customer Care if your system does not function as described below. For contact information, visit [verathon.com/service-and-support](http://verathon.com/service-and-support).

1. Fully charge the monitor battery (this may take up to approximately 6 hours).
2. Attach a video cable and scope to the monitor. For information on cable and scope configurations that are compatible with your monitor, see [Setting Up](#) on page 17.
3. Press the **Power** button. The monitor turns on.
4. Look at the monitor screen, and verify that the image displayed is being received from the scope.

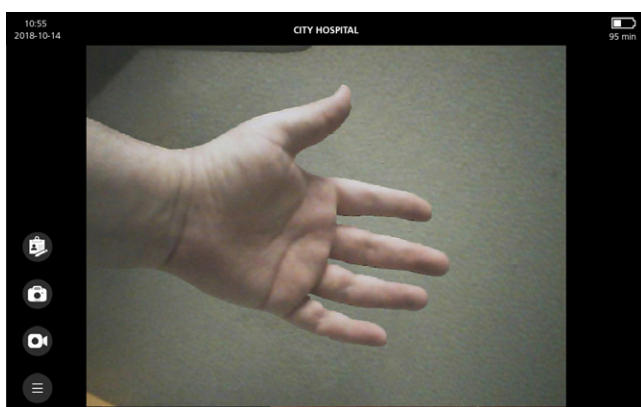

*Note: There may be a slight blade intrusion in the upper-left corner of the monitor, and a thin line may appear along the top. These blade edges are captured in the view because of the wide-angle camera lens used in the video laryngoscope. This image acts as a frame of reference during the intubation process and ensures that the orientation of the image is correct in the monitor.*

5. To complete a functional check on the monitor, see the **Perform a Functional Check** procedure in your monitor's operations and maintenance manual.

# Using the Device



Please read the [Hoiatused ja ettevaatusabinõud](#) section before performing the following tasks.

Prior to using the device, set up the device according to the instructions in the chapter [Setting Up](#), and then verify the setup by completing the procedure [Perform a Functional Check](#).

Video batons and Reusable Titanium video laryngoscopes are equipped with the Reveal anti-fog feature, which reduces camera fogging during the intubation procedure. To fully optimize the feature, you must allow the video laryngoscope to warm up for 30-120 seconds prior to use, depending on the ambient temperature and humidity of the clinical environment. Full optimization of the anti-fog feature is not necessary in order to use the device; if desired, you may begin the intubation procedure immediately.

*Note: If the video laryngoscope is stored in cold conditions, additional warming time may be required for optimal performance of the anti-fog feature.*

This chapter consists of the following procedures:

- [Prepare the Scope](#)
  - [Option 1: Video Batons](#)
  - [Option 2: Reusable & Single-Use Video Laryngoscopes](#)
- [Intubate the Patient](#)
  - [Option 1: LoPro Blade or GVL Stat](#)
  - [Option 2: Mac-Style or Miller-Style Blade](#)

---

## Procedure 1. Prepare the Scope

---

### IMPORTANT

Ensure that each component has been properly cleaned, disinfected, or sterilized according to the guidance provided in the [Reprocessing](#) chapter.

---

### Option 1. Video Batons

---

Ensure that the video monitor is turned off prior to connecting or disconnecting the video cable.

1. Based on a clinical assessment of the patient and the experience and judgment of the clinician, select the video baton and GVL Stat combination that is appropriate for the patient.
2. Attach the video cable and video laryngoscope to the monitor, according to the instructions in [Attach the Video Cable to the Monitor](#) on page 18.
3. If you are using a Video Baton 2.0 Large (3-4), attach the baton to the cable, according to the instructions in [Attach the Scope to the Video Cable](#) on page 18.
4. Turn on the video monitor.
5. Ensure that the battery is sufficiently charged. If necessary, connect the monitor directly to power.

## Insert the Video Baton into the GVL Stat

6. Open the GVL Stat pouch, but do not remove the Stat from the packaging.
7. Ensure that the logo on the side of the baton and the logo on the side of the Stat are aligned.
8. Slide the video baton into the GVL Stat until it clicks into place. Do not remove the Stat from the pouch until you are ready to begin the intubation. This ensures that the Stat remains as clean as possible.

*Note: Ensure that you do not insert the video baton backwards.*

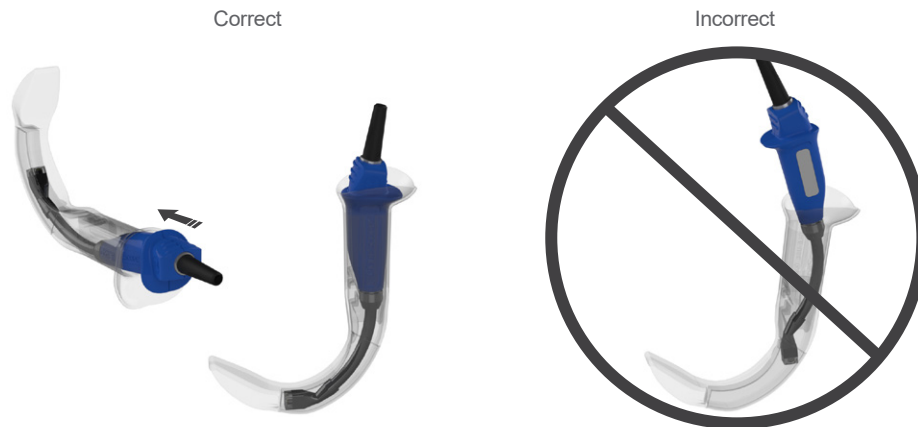

9. When you remove the GVL Stat from the packaging, visually inspect the Stat to ensure that all exterior surfaces are free of unintended rough areas, sharp edges, protrusions, or cracks.

## Option 2. Reusable & Single-Use Video Laryngoscopes

---

1. Based on a clinical assessment of the patient and the experience and judgment of the clinician, select the GlideScope video laryngoscope that is appropriate for the patient.
2. Attach the video cable and video laryngoscope to the monitor, according to the instructions in [Attach the Video Cable to the Monitor](#) on page 18.
3. Turn on the video monitor.
4. Ensure that the battery is sufficiently charged. If necessary, connect the monitor directly to power.
5. On the monitor screen, verify that the image displayed is from the video laryngoscope camera. A small portion of the blade may be visible on the upper-left corner or top of the monitor screen.
6. If needed, allow the anti-fog feature to warm up for 30–120 seconds.

*Note: The time required for the anti-fog feature to be fully optimized varies according to the ambient temperature and humidity where the equipment is being stored or used. If the video laryngoscope is stored in cold conditions, additional warming time may be required for optimal performance of the anti-fog feature.*

7. If desired to provide additional anti-fog benefits, you may apply Dexide Fred or Dexide Fred Lite to the camera window on the reusable blade.\* Use the solution according to the manufacturer's instructions.

\* Compatibility has been demonstrated for up to 100 cycles on reusable video laryngoscopes.

---

## Procedure 2. Intubate the Patient

---



Please read the [Hoiatused ja ettevaatusabinõud](#) section before performing the following tasks.

To perform an intubation, Verathon recommends using one of the following techniques appropriate for the style laryngoscope being used. Prior to beginning this procedure, verify that the monitor is receiving an accurate image from the video laryngoscope.

---

### Option 1. LoPro Blade or GVL Stat

---

If you are using a Mac-style or Miller-style blade, skip to the next option, Mac-Style or Miller-Style Blade.

1. Stabilize the patient's head.
2. Look in the mouth, insert the blade midline, and then advance the tip into the vallecula.
3. Look at the screen, and then lift the epiglottis for a view of the larynx.
4. Look in the mouth, and then introduce an endotracheal tube alongside the blade.
5. Look at the screen, and then complete the intubation.
6. If using a GlideRite Rigid Stylet, remove it by pulling toward the patient's feet.

---

### Option 2. Mac-Style or Miller-Style Blade

---

1. If the patient's condition allows, place the head in a sniffing position.
2. Look in the mouth, insert the blade into the right side, and then sweep the tongue left.
3. Lift the blade for the best view of the larynx.
4. Look in the mouth, and then introduce an endotracheal tube alongside the blade.
5. Complete the intubation.

---

## Procedure 3. Prepare a Component for Cleaning

---

1. Make sure the video monitor has been turned off.
2. Detach the video cable or scope from the monitor by doing one of the following:
  - GlideScope Video Monitor—Turn the connector ring in the direction of the release arrow, and then pull.
  - Core monitor—Hold the cable connector in one hand and support the monitor with the other, and then pull.
  - Go 2 monitor— hold the monitor in one hand and the scope's body in the other, and then pull.

If you are cleaning a video laryngoscope or baton with a detachable video cable, make sure to also detach the cable from the scope.

Figure 10. GlideScope Video Monitor



Figure 11. Core Monitor



3. Prior to cleaning or disinfecting AVL video batons, ensure that the protective cap is properly fitted on the cable connector. The arrow on the connector plug should line up with the dot on the protective cap. Video Baton 2.0, Titanium reusable video laryngoscopes, GlideScope Video Cables, GlideScope Smart Cables, Core Video Cables, and Core Smart Cables do not require a protective cap.



Correct fitting



Incorrect fitting

4. Optionally, to prevent contaminants from drying onto the surface of the device, apply a pre-cleaner to the component. Bodily contaminants tend to become securely attached to solid surfaces when dried, making removal more difficult.

# Reprocessing

---

Some of the components in this manual may require cleaning, low-level disinfection, high-level disinfection, or sterilization between uses or under specific circumstances. For information about the cleaning, disinfection, and sterilization requirements for these components, refer to the GlideScope and GlideRite Products Reprocessing Manual, which is available at [verathon.com/service-and-support/glidescope-reprocessing-products](https://www.verathon.com/service-and-support/glidescope-reprocessing-products).

# Hooldus ja ohutus



Enne järgmiste toimingute tegemist lugege jaotist [Hoiatused ja ettevaatusabinõud](#).

## Korralised kontrollid

Verathon ei nõua korralisi kontrole, hooldust ega kalibreerimisi.

Teavitage Verathon klienditeenindust või kohalikku esindajat kõigist oletatavatest vigadest. Vaadake kontaktteavet veebilehelt [verathon.com/service-and-support](http://verathon.com/service-and-support).

## Elueerimise sobivus

Korduskasutatava videolarüngoskoobiga GlideScope Titanium kasutamiseks katsetas Verathon sobivust 1% naatriumdodetsüülsulfaadi (SDS) lahusega, mille pH oli 11,0.

SDSi lahust kasutatakse Euroopas tavaliselt elueerimislahusena, et koguda jääkvalgu proovid meditsiinivahenditelt või -seadmetelt, mida puhastatakse pärast patsiendi koega kokkupuudet. Seejärel uuritakse valguproovi lahust haigla puhastusprotsessi kontrollimiseks.

Katsest selgus, et 1% SDS-lahus, mille pH on 11,0, on keemiliselt sobiv korduskasutatavate videolarüngoskoopidega ega põhjusta kõrvalmõjusid, kui tehakse korduvat 30-minutilist leotamist 100 tsükli vältel.

## Seadme parandamine

Süsteemi komponendid ei ole kasutajate hooldatavad. Verathon ei avalda ühtegi elektriskeemi, komponentide ja osade loendit, kirjeldust ega muud teavet, mida oleks vaja seadme ja selle tarvikute parandamiseks. Kõik hooldustööd peab tegema kvalifitseeritud tehnik.

Kui teil on küsimusi, võtke ühendust Verathon kohaliku esindaja või Verathon klienditeenindusega.

## Seadme kõrvaldamine

Seadme kasutuselt kõrvaldamist elektri- ja elektroonikaseadmete romude käitlusnõuete kohaselt saab korraldada Verathon hoolduskeskuse kaudu. Teise võimalusena järgige ohtlike jäätmete kõrvaldamise kohalikke eeskirju.



# Limited Warranty

---

## ORIGINAL TOTAL CUSTOMER CARE WARRANTY

This Limited Warranty (“Warranty”) is provided by Verathon Inc. (“Verathon”) to its customer, distributor, original equipment manufacturer, end-user, or other purchaser (“Buyer”) on the terms and conditions stated herein, for the GlideScope product (“Product”). The terms of this Warranty are subject to the standard Terms and Conditions of Sale or any other separate negotiated agreement between the parties.

**SCOPE OF COVERAGE:** This Warranty covers service and repair of all malfunctions (mechanical, electrical, and other defects) associated with the Product purchased by Buyer from Verathon, including coverage for accidental drops or mishandling of Product (subject to Buyer’s payment of a deductible charge for Product replacement), for a period of one (1) year (unless otherwise noted under “COVERED COMPONENTS” below) from Product shipment date (“Term”), and applies only to the original Buyer. Replacement parts will be new, rebuilt or non-original manufacturer’s parts that perform to the factory specifications of the Product at Verathon’s sole option.

Verathon will perform repair and replacement services (“Service”) only on Products purchased from an authorized dealer. If the Product or component is purchased from an unauthorized dealer, or if the original factory serial number has been removed, defaced or altered, this Warranty is void.

If a Product purchased by Buyer requires Service, Verathon will, at its discretion, either repair or replace the Product and may provide a loaner unit, at Buyer’s request. If Buyer requests a loaner unit, Buyer shall send the defective Product to Verathon (cleaned and disinfected as appropriate) immediately upon receiving the loaner unit from Verathon. Buyer shall return the loaner unit within two (2) business days of receipt of the repaired Product. All exchanged parts become property of Verathon.

**EXCLUSIONS:** This Warranty excludes problems caused by the Buyer’s acts (or failure to act), the acts of others, or events beyond Verathon’s reasonable control including:

- Accident, theft, misuse, abuse, extraordinary wear and tear, or neglect.
- Misapplication, improper use, or other failure to follow Verathon’s product instructions and safety precautions contained in the Operations and Maintenance Manual. This warranty does not apply if there is evidence of the equipment being exposed to temperatures in excess of 60°C (140°F).
- Use of the system in conjunction with hardware, software, components, services, accessories, attachments, interfaces, or consumables, other than those supplied or specified by Verathon.
- Products that have been repaired or maintained by anyone other than a Verathon authorized service provider.
- Modification, disassembly, rewiring, re-engineering, recalibration, and/or reprogramming of Products other than as specifically authorized by Verathon in writing.

**COVERED COMPONENTS:** Warranty coverage applies to the following components:

- GlideScope AVL Video Batons
- GlideScope Titanium Reusable video laryngoscopes
- GlideScope video cables
- GlideScope Core QuickConnect Cable
- GlideScope Video Baton 2.0 Large (two-year factory warranty)
- GlideScope Core Smart Cable (two-year factory warranty)
- GlideScope Video Baton QC Large (two-year factory warranty)

Additional reusable components purchased either singularly or as a part of a system, including GlideScope Workstations and the GlideScope Video Cable, are limited to a one-year factory warranty unless stated otherwise. Consumable items are not covered under this warranty.

**EXTENDED WARRANTIES:** Buyer may purchase a Premium Total Customer Care warranty that extends this Limited Warranty. For more information, contact Verathon's Customer Care Department or your local representative.

**LIMITED REMEDY:** This Warranty gives Buyer specific legal rights which may vary based on local law. When, under applicable law, implied warranties are not allowed to be excluded in their entirety, such warranties will be limited to the duration of the applicable written warranty and, for European Customers, any terms herein limiting Verathon's liability shall not apply insofar as they conflict with mandatory statutory provisions of the Product Liability Act.

TO THE FULL EXTENT ALLOWED BY LAW, THE FOREGOING LIMITED WARRANTIES AND REMEDIES ARE EXCLUSIVE AND EXPRESSLY IN LIEU OF ALL OTHER WARRANTIES, REPRESENTATIONS, TERMS, OR CONDITIONS, WRITTEN OR ORAL, EXPRESS OR IMPLIED, STATUTORY OR OTHERWISE, INCLUDING BUT NOT LIMITED TO ANY WARRANTIES, TERMS OR CONDITIONS OF MERCHANTABILITY OR FITNESS FOR A PARTICULAR PURPOSE, SATISFACTORY QUALITY, CORRESPONDENCE WITH DESCRIPTION, AND NON-INFRINGEMENT, ALL OF WHICH ARE HEREBY EXPRESSLY DISCLAIMED.

**TRANSFER OF SERVICE:** This Warranty extends only to Buyer, and may not be transferred to third parties by operation of law or otherwise.

# Product Specifications

## Component Specifications

### Reusable Video Laryngoscope Specifications

Table 9. Titanium LoPro T2 (0574-0196)

GENERAL SPECIFICATIONS		
Ingress protection:	IPX8	
Expected product life:	3 years or 3000 cycles	
OPERATING & SHIPPING SPECIFICATIONS		
	Operating Conditions	Shipping & Storage Conditions
Temperature:	10–35°C (50–95°F)	-20–45°C (-4–113°F)
Relative humidity:	10–95%	10–95%
Atmospheric pressure:	700–1060 hPa	440–1060 hPa
COMPONENT SPECIFICATIONS		
Height at handle (A)	8.5 mm	
Height at camera (B)	9.5 mm	
Blade tip to handle (C)	44.0 mm	
Width at camera (D)	13.9 mm	

Table 10. Titanium LoPro T3 (0574-0126)

GENERAL SPECIFICATIONS		
Ingress protection:	IPX8	
Expected product life:	3 years or 3000 cycles	
OPERATING & SHIPPING SPECIFICATIONS		
	Operating Conditions	Shipping & Storage Conditions
Temperature:	10–35°C (50–95°F)	-20–45°C (-4–113°F)
Relative humidity:	10–95%	10–95%
Atmospheric pressure:	700–1060 hPa	440–1060 hPa
COMPONENT SPECIFICATIONS		
Height at handle (A)	10.8 mm	
Height at camera (B)	10.5 mm	
Blade tip to handle (C)	72.0 mm	
Width at camera (D)	20.0 mm	

Table 11. Titanium LoPro T4 (0574-0127)

GENERAL SPECIFICATIONS		
Ingress protection:	IPX8	
Expected product life:	3 years or 3000 cycles	
OPERATING & SHIPPING SPECIFICATIONS		
	Operating Conditions	Shipping & Storage Conditions
Temperature:	10–35°C (50–95°F)	-20–45°C (-4–113°F)
Relative humidity:	10–95%	10–95%
Atmospheric pressure:	700–1060 hPa	440–1060 hPa
COMPONENT SPECIFICATIONS		
Height at handle (A)	11.0 mm	
Height at camera (B)	10.0 mm	
Blade tip to handle (C)	91.0 mm	
Width at camera (D)	25.0 mm	

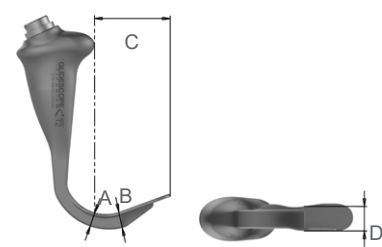
Table 12. Titanium MAC T3 (0574-0128)

GENERAL SPECIFICATIONS		
Ingress protection:	IPX8	
Expected product life:	3 years or 3000 cycles	
OPERATING & SHIPPING SPECIFICATIONS		
	Operating Conditions	Shipping & Storage Conditions
Temperature:	10–35°C (50–95°F)	-20–45°C (-4–113°F)
Relative humidity:	10–95%	10–95%
Atmospheric pressure:	700–1060 hPa	440–1060 hPa
COMPONENT SPECIFICATIONS		
Height at handle (A)	10.8 mm	
Height at camera (B)	10.5 mm	
Blade tip to handle (C)	72.0 mm	
Width at camera (D)	20.0 mm	

Table 13. Titanium MAC T4 (0574-0129)

GENERAL SPECIFICATIONS		
Ingress protection:	IPX8	
Expected product life:	3 years or 3000 cycles	
OPERATING & SHIPPING SPECIFICATIONS		
	Operating Conditions	Shipping & Storage Conditions
Temperature:	10–35°C (50–95°F)	-20–45°C (-4–113°F)
Relative humidity:	10–95%	10–95%
Atmospheric pressure:	700–1060 hPa	440–1060 hPa
COMPONENT SPECIFICATIONS		
Height at handle (A)	13.4 mm	
Height at camera (B)	9.6 mm	
Blade tip to handle (C)	128.0 mm	
Width at camera (D)	22.0 mm	

# Single-use Video Laryngoscope Specifications

Table 14. Spectrum Miller S0 (Sterile 0574-0202, Non-Sterile 0574-0216)

GENERAL SPECIFICATIONS			
Ingress protection:	IPX4		
Expected product life:	Refer to the “use by” date indicated by the  symbol on the package label.		
OPERATING, SHIPPING, & STORAGE SPECIFICATIONS			
	Operating Conditions	Shipping Conditions	Storage Conditions
Temperature:	10–40°C (50–104°F)	-20–45°C (-4–113°F)	18–28°C (64–82°F)
Relative humidity:	10–95%	10–95%	40–60%
Atmospheric pressure:	700–1060 hPa	440–1060 hPa	1013 hPa
COMPONENT SPECIFICATIONS			
Height at handle (A)	12.1 mm		
Height at camera (B)	12.2 mm		
Blade tip to handle (C)	55.5 mm		
Width at camera (D)	15.3 mm		

Table 15. Spectrum Miller S1 (Sterile 0574-0203, Non-Sterile 0574-0217)

GENERAL SPECIFICATIONS			
Ingress protection:	IPX4		
Expected product life:	Refer to the “use by” date indicated by the  symbol on the package label.		
OPERATING, SHIPPING, & STORAGE SPECIFICATIONS			
	Operating Conditions	Shipping Conditions	Storage Conditions
Temperature:	10–40°C (50–104°F)	-20–45°C (-4–113°F)	18–28°C (64–82°F)
Relative humidity:	10–95%	10–95%	40–60%
Atmospheric pressure:	700–1060 hPa	440–1060 hPa	1013 hPa
COMPONENT SPECIFICATIONS			
Height at handle (A)	12.1 mm		
Height at camera (B)	12.2 mm		
Blade tip to handle (C)	81.5 mm		
Width at camera (D)	15.3 mm		

Table 16. Spectrum LoPro S1 (Sterile 0574-0165, Non-Sterile 0574-0218)

GENERAL SPECIFICATIONS			
Ingress protection:	IPX4		
Expected product life:	Refer to the “use by” date indicated by the  symbol on the package label.		
OPERATING, SHIPPING, & STORAGE SPECIFICATIONS			
	Operating Conditions	Shipping Conditions	Storage Conditions
Temperature:	10–40°C (50–104°F)	-20–45°C (-4–113°F)	18–28°C (64–82°F)
Relative humidity:	10–95%	10–95%	40–60%
Atmospheric pressure:	700–1060 hPa	440–1060 hPa	1013 hPa
COMPONENT SPECIFICATIONS			
Height at handle (A)	8.7 mm		
Height at camera (B)	9.6 mm		
Blade tip to handle (C)	29.0 mm		
Width at camera (D)	12.2 mm		

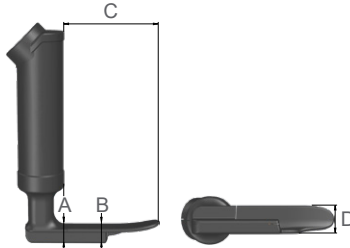
Table 17. Spectrum LoPro S2 (Sterile 0574-0166, Non-Sterile 0574-0219)

GENERAL SPECIFICATIONS			
Ingress protection:	IPX4		
Expected product life:	Refer to the “use by” date indicated by the  symbol on the package label.		
OPERATING, SHIPPING, & STORAGE SPECIFICATIONS			
	Operating Conditions	Shipping Conditions	Storage Conditions
Temperature:	10–40°C (50–104°F)	-20–45°C (-4–113°F)	18–28°C (64–82°F)
Relative humidity:	10–95%	10–95%	40–60%
Atmospheric pressure:	700–1060 hPa	440–1060 hPa	1013 hPa
COMPONENT SPECIFICATIONS			
Height at handle (A)	8.7 mm		
Height at camera (B)	9.6 mm		
Blade tip to handle (C)	44.0 mm		
Width at camera (D)	13.0 mm		

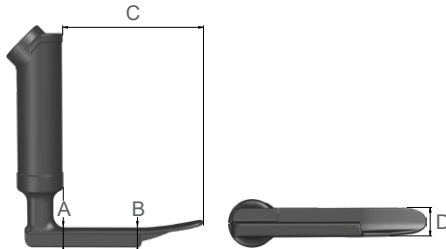
Table 18. Spectrum LoPro S2.5 (Sterile 0574-0201, Non-Sterile 0574-0220)

GENERAL SPECIFICATIONS			
Ingress protection:	IPX4		
Expected product life:	Refer to the “use by” date indicated by the ☒ symbol on the package label.		
OPERATING, SHIPPING, & STORAGE SPECIFICATIONS			
	Operating Conditions	Shipping Conditions	Storage Conditions
Temperature:	10–40°C (50–104°F)	-20–45°C (-4–113°F)	18–28°C (64–82°F)
Relative humidity:	10–95%	10–95%	40–60%
Atmospheric pressure:	700–1060 hPa	440–1060 hPa	1013 hPa
COMPONENT SPECIFICATIONS			
Height at handle (A)	10.3 mm		
Height at camera (B)	9.6 mm		
Blade tip to handle (C)	57.0 mm		
Width at camera (D)	16.0 mm		

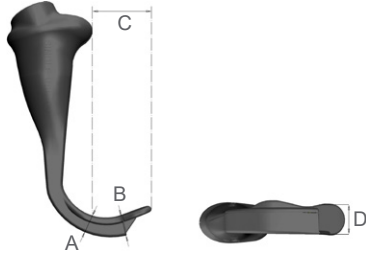
Table 19. Spectrum LoPro S3 (Sterile 0574-0194, Non-Sterile 0574-0221)

GENERAL SPECIFICATIONS			
Ingress protection:	IPX4		
Expected product life:	Refer to the “use by” date indicated by the ☒ symbol on the package label.		
OPERATING, SHIPPING, & STORAGE SPECIFICATIONS			
	Operating Conditions	Shipping Conditions	Storage Conditions
Temperature:	10–40°C (50–104°F)	-20–45°C (-4–113°F)	18–28°C (64–82°F)
Relative humidity:	10–95%	10–95%	40–60%
Atmospheric pressure:	700–1060 hPa	440–1060 hPa	1013 hPa
COMPONENT SPECIFICATIONS			
Height at handle (A)	11.0 mm		
Height at camera (B)	11.0 mm		
Blade tip to handle (C)	74.0 mm		
Width at camera (D)	20.0 mm		

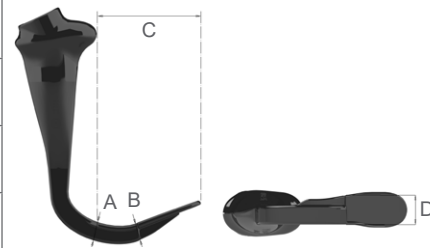

Table 20. Spectrum LoPro S4 (Sterile 0574-0195, Non-Sterile 0574-0222)

GENERAL SPECIFICATIONS			
Ingress protection:	IPX4		
Expected product life:	Refer to the “use by” date indicated by the ☞ symbol on the package label.		
OPERATING, SHIPPING, & STORAGE SPECIFICATIONS			
	Operating Conditions	Shipping Conditions	Storage Conditions
Temperature:	10–40°C (50–104°F)	-20–45°C (-4–113°F)	18–28°C (64–82°F)
Relative humidity:	10–95%	10–95%	40–60%
Atmospheric pressure:	700–1060 hPa	440–1060 hPa	1013 hPa
COMPONENT SPECIFICATIONS			
Height at handle (A)	12.0 mm		
Height at camera (B)	11.3 mm		
Blade tip to handle (C)	91.0 mm		
Width at camera (D)	25.0 mm		

Table 21. Spectrum MAC S3 (Sterile 0574-0187, Non-Sterile 0574-0223)

GENERAL SPECIFICATIONS			
Ingress protection:	IPX4		
Expected product life:	Refer to the “use by” date indicated by the ☞ symbol on the package label.		
OPERATING, SHIPPING, & STORAGE SPECIFICATIONS			
	Operating Conditions	Shipping Conditions	Storage Conditions
Temperature:	10–40°C (50–104°F)	-20–45°C (-4–113°F)	18–28°C (64–82°F)
Relative humidity:	10–95%	10–95%	40–60%
Atmospheric pressure:	700–1060 hPa	440–1060 hPa	1013 hPa
COMPONENT SPECIFICATIONS			
Height at handle (A)	14.6 mm		
Height at camera (B)	11.7 mm		
Blade tip to handle (C)	107.5 mm		
Width at camera (D)	26.6 mm		

Table 22. Spectrum MAC S4 (Sterile 0574-0188, Non-Sterile 0574-0224)

GENERAL SPECIFICATIONS			
Ingress protection:	IPX4		
Expected product life:	Refer to the “use by” date indicated by the ☒ symbol on the package label.		
OPERATING, SHIPPING, & STORAGE SPECIFICATIONS			
	Operating Conditions	Shipping Conditions	Storage Conditions
Temperature:	10–40°C (50–104°F)	-20–45°C (-4–113°F)	18–28°C (64–82°F)
Relative humidity:	10–95%	10–95%	40–60%
Atmospheric pressure:	700–1060 hPa	440–1060 hPa	1013 hPa
COMPONENT SPECIFICATIONS			
Height at handle (A)	14.3 mm		
Height at camera (B)	11.4 mm		
Blade tip to handle (C)	128.0 mm		
Width at camera (D)	26.4 mm		

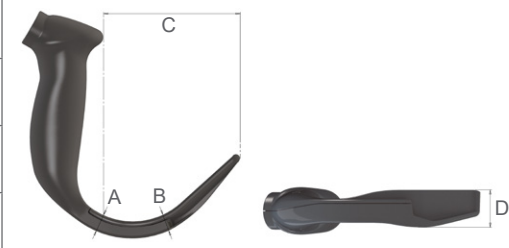
Table 23. Spectrum QC Hyperangle S1 (0574-0232)

GENERAL SPECIFICATIONS			
Ingress protection:	IPX4		
Expected product life:	Refer to the “use by” date indicated by the ☒ symbol on the package label.		
OPERATING, SHIPPING, & STORAGE SPECIFICATIONS			
	Operating Conditions	Shipping Conditions	Storage Conditions
Temperature:	10–40°C (50–104°F)	-20–45°C (-4–113°F)	18–28°C (64–82°F)
Relative humidity:	10–95%	10–95%	40–60%
Atmospheric pressure:	700–1060 hPa	440–1060 hPa	1013 hPa
COMPONENT SPECIFICATIONS			
Height at handle (A)	8.7 mm		
Height at camera (B)	9.6 mm		
Blade tip to handle (C)	29.0 mm		
Width at camera (D)	12.2 mm		

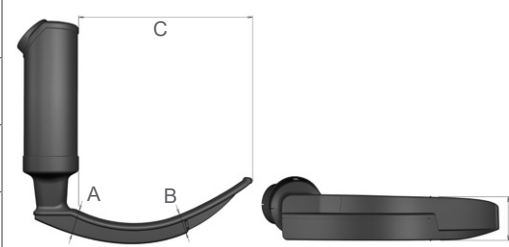
Table 24. Spectrum QC Hyperangle S2 (0574-0233)

GENERAL SPECIFICATIONS			
Ingress protection:	IPX4		
Expected product life:	Refer to the “use by” date indicated by the ☒ symbol on the package label.		
OPERATING, SHIPPING, & STORAGE SPECIFICATIONS			
	Operating Conditions	Shipping Conditions	Storage Conditions
Temperature:	10–40°C (50–104°F)	-20–45°C (-4–113°F)	18–28°C (64–82°F)
Relative humidity:	10–95%	10–95%	40–60%
Atmospheric pressure:	700–1060 hPa	440–1060 hPa	1013 hPa
COMPONENT SPECIFICATIONS			
Height at handle (A)	8.7 mm		
Height at camera (B)	9.6 mm		
Blade tip to handle (C)	44.0 mm		
Width at camera (D)	13.0 mm		

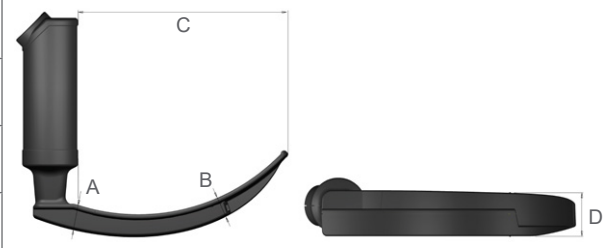
Table 25. Spectrum QC Hyperangle S2.5 (0574-0234)

GENERAL SPECIFICATIONS			
Ingress protection:	IPX4		
Expected product life:	Refer to the “use by” date indicated by the ☒ symbol on the package label.		
OPERATING, SHIPPING, & STORAGE SPECIFICATIONS			
	Operating Conditions	Shipping Conditions	Storage Conditions
Temperature:	10–40°C (50–104°F)	-20–45°C (-4–113°F)	18–28°C (64–82°F)
Relative humidity:	10–95%	10–95%	40–60%
Atmospheric pressure:	700–1060 hPa	440–1060 hPa	1013 hPa
COMPONENT SPECIFICATIONS			
Height at handle (A)	10.3 mm		
Height at camera (B)	9.6 mm		
Blade tip to handle (C)	57.0 mm		
Width at camera (D)	16.0 mm		

Table 26. Spectrum QC Hyperangle S3 (0574-0225)

GENERAL SPECIFICATIONS			
Ingress protection:	IPX4		
Expected product life:	Refer to the “use by” date indicated by the ☒ symbol on the package label.		
OPERATING, SHIPPING, & STORAGE SPECIFICATIONS			
	Operating Conditions	Shipping Conditions	Storage Conditions
Temperature:	10–40°C (50–104°F)	-20–45°C (-4–113°F)	18–28°C (64–82°F)
Relative humidity:	10–95%	10–95%	40–60%
Atmospheric pressure:	700–1060 hPa	440–1060 hPa	1013 hPa
COMPONENT SPECIFICATIONS			
Height at handle (A)	11.0 mm		
Height at camera (B)	11.0 mm		
Blade tip to handle (C)	74.0 mm		
Width at camera (D)	20.0 mm		

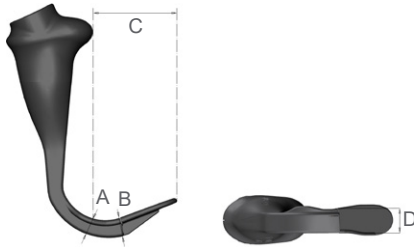
Table 27. Spectrum QC Hyperangle S4 (0574-0226)

GENERAL SPECIFICATIONS			
Ingress protection:	IPX4		
Expected product life:	Refer to the “use by” date indicated by the ☒ symbol on the package label.		
OPERATING, SHIPPING, & STORAGE SPECIFICATIONS			
	Operating Conditions	Shipping Conditions	Storage Conditions
Temperature:	10–40°C (50–104°F)	-20–45°C (-4–113°F)	18–28°C (64–82°F)
Relative humidity:	10–95%	10–95%	40–60%
Atmospheric pressure:	700–1060 hPa	440–1060 hPa	1013 hPa
COMPONENT SPECIFICATIONS			
Height at handle (A)	12.0 mm		
Height at camera (B)	11.3 mm		
Blade tip to handle (C)	91.0 mm		
Width at camera (D)	25.0 mm		

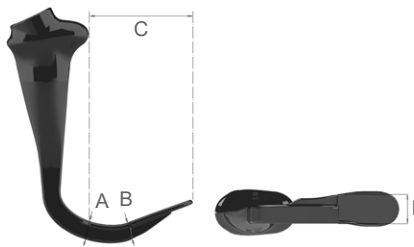
Table 28. Spectrum QC Miller S0 (0574-0230)

GENERAL SPECIFICATIONS			
Ingress protection:	IPX4		
Expected product life:	Refer to the “use by” date indicated by the  symbol on the package label.		
OPERATING, SHIPPING, & STORAGE SPECIFICATIONS			
	Operating Conditions	Shipping Conditions	Storage Conditions
Temperature:	10–40°C (50–104°F)	-20–45°C (-4–113°F)	18–28°C (64–82°F)
Relative humidity:	10–95%	10–95%	40–60%
Atmospheric pressure:	700–1060 hPa	440–1060 hPa	1013 hPa
COMPONENT SPECIFICATIONS			
Height at handle (A)	12.1 mm		
Height at camera (B)	12.2 mm		
Blade tip to handle (C)	55.5 mm		
Width at camera (D)	15.3 mm		

Table 29. Spectrum QC Miller S1 (0574-0231)

GENERAL SPECIFICATIONS			
Ingress protection:	IPX4		
Expected product life:	Refer to the “use by” date indicated by the  symbol on the package label.		
OPERATING, SHIPPING, & STORAGE SPECIFICATIONS			
	Operating Conditions	Shipping Conditions	Storage Conditions
Temperature:	10–40°C (50–104°F)	-20–45°C (-4–113°F)	18–28°C (64–82°F)
Relative humidity:	10–95%	10–95%	40–60%
Atmospheric pressure:	700–1060 hPa	440–1060 hPa	1013 hPa
COMPONENT SPECIFICATIONS			
Height at handle (A)	12.1 mm		
Height at camera (B)	12.2 mm		
Blade tip to handle (C)	81.5 mm		
Width at camera (D)	15.3 mm		

Table 30. Spectrum QC MAC S3 (0574-0227)

GENERAL SPECIFICATIONS			
Ingress protection:	IPX4		
Expected product life:	Refer to the “use by” date indicated by the ☒ symbol on the package label.		
OPERATING, SHIPPING, & STORAGE SPECIFICATIONS			
	Operating Conditions	Shipping Conditions	Storage Conditions
Temperature:	10–40°C (50–104°F)	-20–45°C (-4–113°F)	18–28°C (64–82°F)
Relative humidity:	10–95%	10–95%	40–60%
Atmospheric pressure:	700–1060 hPa	440–1060 hPa	1013 hPa
COMPONENT SPECIFICATIONS			
Height at handle (A)	14.6 mm		
Height at camera (B)	11.7 mm		
Blade tip to handle (C)	107.5 mm		
Width at camera (D)	26.6 mm		

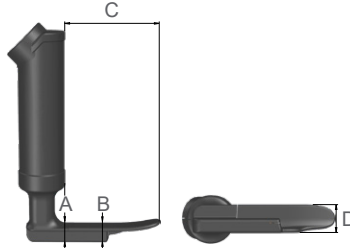
Table 31. Spectrum QC MAC S4 (0574-0228)

GENERAL SPECIFICATIONS			
Ingress protection:	IPX4		
Expected product life:	Refer to the “use by” date indicated by the ☒ symbol on the package label.		
OPERATING, SHIPPING, & STORAGE SPECIFICATIONS			
	Operating Conditions	Shipping Conditions	Storage Conditions
Temperature:	10–40°C (50–104°F)	-20–45°C (-4–113°F)	18–28°C (64–82°F)
Relative humidity:	10–95%	10–95%	40–60%
Atmospheric pressure:	700–1060 hPa	440–1060 hPa	1013 hPa
COMPONENT SPECIFICATIONS			
Height at handle (A)	14.3 mm		
Height at camera (B)	11.4 mm		
Blade tip to handle (C)	128.0 mm		
Width at camera (D)	26.4 mm		

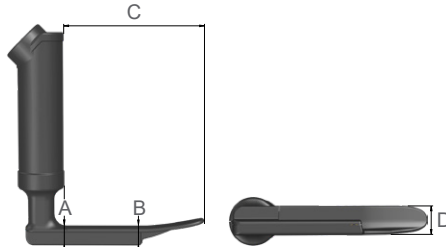
# Video Baton Specifications

Table 32. Video Baton 1-2 (0570-0306)

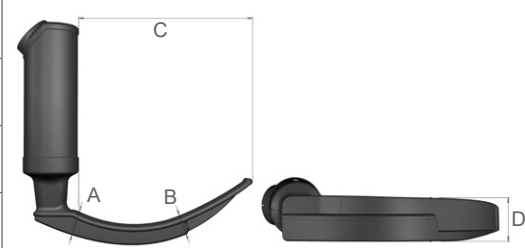
GENERAL SPECIFICATIONS		
Ingress protection:	IPX8	
Expected product life:	2 years or 1000 cycles	
OPERATING & SHIPPING SPECIFICATIONS		
	Operating Conditions	Shipping & Storage Conditions
Temperature:	10–40°C (50–104°F)	-20–45°C (-4–113°F)
Relative humidity:	10–95%	10–95%
Atmospheric pressure:	700–1060 hPa	440–1060 hPa
COMPONENT SPECIFICATIONS		
Length of flexible portion of baton (A)	66.0 mm	 <p>Cable shortened for illustrative purposes</p>
Height at camera (B)	6.0 mm	
Width at camera (C)	7.0 mm	
Video cable length (D)	2041 ± 50 mm	
Field of view (E)	41°	
Direction of view	0°	

Table 33. Video Baton 3-4 (0570-0307)

GENERAL SPECIFICATIONS		
Ingress protection:	IPX8	
Expected product life:	2 years or 1000 cycles	
OPERATING & SHIPPING SPECIFICATIONS		
	Operating Conditions	Shipping & Storage Conditions
Temperature:	10–40°C (50–104°F)	-20–45°C (-4–113°F)
Relative humidity:	10–95%	10–95%
Atmospheric pressure:	700–1060 hPa	440–1060 hPa
COMPONENT SPECIFICATIONS		
Length of flexible portion of baton (A)	105.0 mm	 <p>Cable shortened for illustrative purposes</p>
Height at camera (B)	11 mm	
Width at camera (C)	11 mm	
Video cable length (D)	1540 ± 50 mm	
Field of view (E)	49°	
Direction of view	0°	

Table 34. Video Baton 2.0 Large (3-4; 0570-0382)

GENERAL SPECIFICATIONS		
Ingress protection:	IPX8	
Expected product life:	2 years or 2000 cycles	
OPERATING & SHIPPING SPECIFICATIONS		
	Operating Conditions	Shipping & Storage Conditions
Temperature:	10–40°C (50–104°F)	-20–45°C (-4–113°F)
Relative humidity:	10–95%	10–95%
Atmospheric pressure:	700–1060 hPa	440–1060 hPa
COMPONENT SPECIFICATIONS		
Length of flexible portion of baton (A)	105.0 mm	
Height at camera (B)	11 mm	
Width at camera (C)	11 mm	
Field of view (E)	49°	
Direction of view	0°	

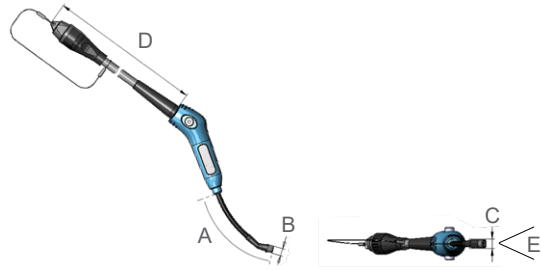
Table 35. GlideScope Video Baton QC Large (0570-0417)

GENERAL SPECIFICATIONS		
Ingress protection:	IPX8	
Expected product life:	2 years or 2000 cycles	
OPERATING & SHIPPING SPECIFICATIONS		
	Operating Conditions	Shipping & Storage Conditions
Temperature:	10–35°C (50–95°F)	-20–45°C (-4–113°F)
Relative humidity:	10–95%	10–95%
Atmospheric pressure:	700–1060 hPa	440–1060 hPa
COMPONENT SPECIFICATIONS		
Length of flexible portion of baton (A)	105.0 mm	
Height at camera (B)	11 mm	
Width at camera (C)	11 mm	
Field of view (E)	49°	
Direction of view	0°	

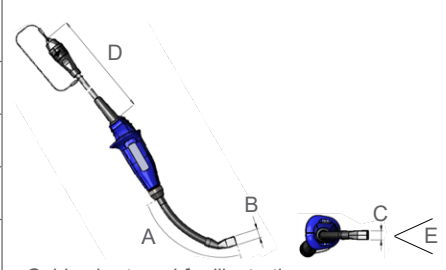

# GVL Stat Specifications

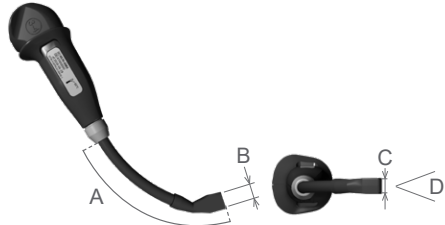
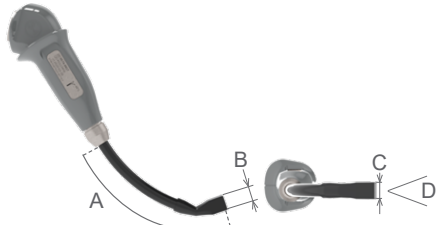
Table 36. GVL Stat 0 (Sterile 0574-0104, Non-Sterile 0574-0236)

GENERAL SPECIFICATIONS			
Expected product life:	Refer to the “use by” date indicated by the ☞ symbol on the package label.		
OPERATING, SHIPPING, & STORAGE SPECIFICATIONS			
	Operating Conditions	Shipping Conditions	Storage Conditions
Temperature:	10–40°C (50–104°F)	0–45°C (32–113°F)	18–28°C (64–82°F)
Relative humidity:	10–95%	10–95%	40–60%
Atmospheric pressure:	700–1060 hPa	800–1060 hPa	1013 hPa
COMPONENT SPECIFICATIONS			
Height at camera (A)	8.6 mm		
Blade tip to handle (B)	36.2 mm		
Width at camera (C)	11.0 mm		
Blade length in front of camera (D)	6.5 mm		
Max blade width in front of camera (E)	11.0 mm		

Table 37. GVL Stat 1 (Sterile 0574-0026, Non-Sterile 0574-0237)

GENERAL SPECIFICATIONS			
Expected product life:	Refer to the “use by” date indicated by the ☞ symbol on the package label.		
OPERATING, SHIPPING, & STORAGE SPECIFICATIONS			
	Operating Conditions	Shipping Conditions	Storage Conditions
Temperature:	10–40°C (50–104°F)	0–45°C (32–113°F)	18–28°C (64–82°F)
Relative humidity:	10–95%	10–95%	40–60%
Atmospheric pressure:	700–1060 hPa	800–1060 hPa	1013 hPa
COMPONENT SPECIFICATIONS			
Height at camera (A)	8.6 mm		
Blade tip to handle (B)	43.5 mm		
Width at camera (C)	10.1 mm		
Blade length in front of camera (D)	15.0 mm		
Max blade width in front of camera (E)	12.7 mm		

Table 38. GVL Stat 2 (Sterile 0574-0027, Non-Sterile 0574-0238)

GENERAL SPECIFICATIONS			
Expected product life:	Refer to the “use by” date indicated by the ⏰ symbol on the package label.		
OPERATING, SHIPPING, & STORAGE SPECIFICATIONS			
	Operating Conditions	Shipping Conditions	Storage Conditions
Temperature:	10–40°C (50–104°F)	0–45°C (32–113°F)	18–28°C (64–82°F)
Relative humidity:	10–95%	10–95%	40–60%
Atmospheric pressure:	700–1060 hPa	800–1060 hPa	1013 hPa
COMPONENT SPECIFICATIONS			
Height at camera (A)	8.6 mm		
Blade tip to handle (B)	55.7 mm		
Width at camera (C)	11.2 mm		
Blade length in front of camera (D)	28.0 mm		
Max blade width in front of camera (E)	16.0 mm		

Table 39. GVL Stat 2.5 (Sterile 0574-0110, Non-Sterile 0574-0239)

GENERAL SPECIFICATIONS			
Expected product life:	Refer to the “use by” date indicated by the ⏰ symbol on the package label.		
OPERATING, SHIPPING, & STORAGE SPECIFICATIONS			
	Operating Conditions	Shipping Conditions	Storage Conditions
Temperature:	10–40°C (50–104°F)	0–45°C (32–113°F)	18–28°C (64–82°F)
Relative humidity:	10–95%	10–95%	40–60%
Atmospheric pressure:	700–1060 hPa	800–1060 hPa	1013 hPa
COMPONENT SPECIFICATIONS			
Height at camera (A)	9.1 mm		
Blade tip to handle (B)	63.4 mm		
Width at camera (C)	12.7 mm		
Blade length in front of camera (D)	37.0 mm		
Max blade width in front of camera (E)	19.7 mm		

Table 40. GVL Stat 3 (Sterile 0574-0100, Non-Sterile 0574-0240)

GENERAL SPECIFICATIONS			
Expected product life:	Refer to the “use by” date indicated by the ⏰ symbol on the package label.		
OPERATING, SHIPPING, & STORAGE SPECIFICATIONS			
	Operating Conditions	Shipping Conditions	Storage Conditions
Temperature:	10–40°C (50–104°F)	-20–45°C (-4–113°F)	18–28°C (64–82°F)
Relative humidity:	10–95%	10–95%	40–60%
Atmospheric pressure:	700–1060 hPa	800–1060 hPa	1013 hPa
COMPONENT SPECIFICATIONS			
Height at camera (A)	14.3 mm		
Blade tip to handle (B)	77.8 mm		
Width at camera (C)	16.0 mm		
Blade length in front of camera (D)	37.0 mm		
Max blade width in front of camera (E)	19.7 mm		

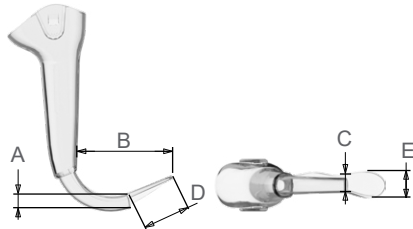
Table 41. GVL Stat 4 (Sterile 0574-0101, Non-Sterile 0574-0241)

GENERAL SPECIFICATIONS			
Expected product life:	Refer to the “use by” date indicated by the ⏰ symbol on the package label.		
OPERATING, SHIPPING, & STORAGE SPECIFICATIONS			
	Operating Conditions	Shipping Conditions	Storage Conditions
Temperature:	10–40°C (50–104°F)	-20–45°C (-4–113°F)	18–28°C (64–82°F)
Relative humidity:	10–95%	10–95%	40–60%
Atmospheric pressure:	700–1060 hPa	800–1060 hPa	1013 hPa
COMPONENT SPECIFICATIONS			
Height at camera (A)	14.3 mm		
Blade tip to handle (B)	92.4 mm		
Width at camera (C)	20.3 mm		
Blade length in front of camera (D)	52.0 mm		
Max blade width in front of camera (E)	27.5 mm		

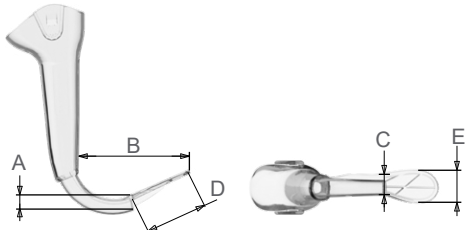
# Cable Specifications

Table 42. Core Smart Cable (0600-0783)

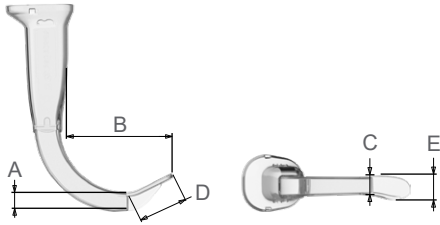
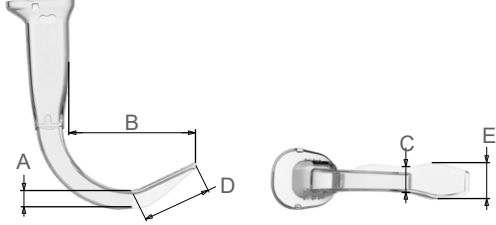
GENERAL SPECIFICATIONS	
Ingress protection:	IPX7
OPERATING & SHIPPING SPECIFICATIONS	
Qualified for use under the conditions of accompanying system components. For more information, see the other component specifications in this chapter, or your monitor's operations and maintenance manual.	
COMPONENT SPECIFICATIONS	
Length (A)	1425 ± 25 mm
Diameter (B)	6.8 mm



The diagram shows two parallel cables. A horizontal dimension line labeled 'A' spans the length of the cables from the blue connector on the left to the silver connector on the right. A vertical dimension line labeled 'B' indicates the diameter of the cables.

Table 43. Core Video Cable (0600-0771)

GENERAL SPECIFICATIONS	
Ingress protection:	IPX7
OPERATING & SHIPPING SPECIFICATIONS	
Qualified for use under the conditions of accompanying system components. For more information, see the other component specifications in this chapter, or your monitor's operations and maintenance manual.	
COMPONENT SPECIFICATIONS	
Length (A)	1524 ± 25 mm
Diameter (B)	6.8 mm



The diagram shows two parallel cables. A horizontal dimension line labeled 'A' spans the length of the cables from the blue connector on the left to the silver connector on the right. A vertical dimension line labeled 'B' indicates the diameter of the cables.

Table 44. Core QuickConnect Cable (0600-0767)

GENERAL SPECIFICATIONS	
Ingress protection:	IPX7
OPERATING & SHIPPING SPECIFICATIONS	
Qualified for use under the conditions of accompanying system components. For more information, see the other component specifications in this chapter, or your monitor's operations and maintenance manual.	
COMPONENT SPECIFICATIONS	
Length (A)	1524 ± 50 mm
Diameter (B)	6.8 mm



The diagram shows two parallel cables. A horizontal dimension line labeled 'A' spans the length of the cables from the blue connector on the left to the blue connector on the right. A vertical dimension line labeled 'B' indicates the diameter of the cables.

Table 45. Core 2m QuickConnect Cable (0600-0843)

GENERAL SPECIFICATIONS	
Ingress protection:	IPX7
OPERATING & SHIPPING SPECIFICATIONS	
Qualified for use under the conditions of accompanying system components. For more information, see the other component specifications in this chapter, or your monitor's operations and maintenance manual.	
COMPONENT SPECIFICATIONS	
Length (A)	1981 ± 50 mm
Diameter (B)	6.8 mm



The diagram shows two parallel cables. Dimension A is the total length of the cable, and dimension B is the diameter of the cable.

Table 46. Spectrum Smart Cable (0800-0543)

GENERAL SPECIFICATIONS	
Ingress protection:	IPX7
OPERATING & SHIPPING SPECIFICATIONS	
Qualified for use under the conditions of accompanying system components. For more information, see the other component specifications in this chapter, or your monitor's operations and maintenance manual.	
COMPONENT SPECIFICATIONS	
Length (A)	1417 ± 25 mm
Diameter (B)	6.8 mm



The diagram shows two parallel cables. Dimension A is the total length of the cable, and dimension B is the diameter of the cable.

Table 47. Titanium Video Cable (0600-0616)

GENERAL SPECIFICATIONS	
Ingress protection:	IPX8
OPERATING & SHIPPING SPECIFICATIONS	
Qualified for use under the conditions of accompanying system components. For more information, see the other component specifications in this chapter, or your monitor's operations and maintenance manual.	
COMPONENT SPECIFICATIONS	
Length (A)	2060 ± 25 mm
Diameter (B)	5.4 mm

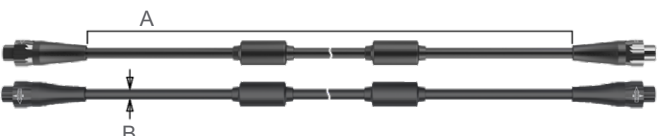

The diagram shows two parallel cables. Dimension A is the total length of the cable, and dimension B is the diameter of the cable.

# Electromagnetic Compatibility

The system is designed to be in compliance with IEC 60601-1-2, which contains electromagnetic compatibility (EMC) requirements for medical electrical equipment. The limits for emissions and immunity specified in this standard are designed to provide reasonable protection against harmful interference in a typical medical installation.

The system complies with the applicable essential performance requirements specified in IEC 60601-1 and IEC 60601-2-18. Results of immunity testing show that the essential performance of the system is not affected under the test conditions described in the following tables. For more information about the essential performance of the system, see [Essential Performance](#) on page 1.

## Electromagnetic Emissions

*Table 48. Guidance and Manufacturer’s Declaration—Electromagnetic Emissions*

The system is intended for use in the electromagnetic environment specified below. The customer or the user of the system should ensure that it is used in such an environment.

EMISSIONS TEST	COMPLIANCE	ELECTROMAGNETIC ENVIRONMENT – GUIDANCE
RF emissions CISPR 11	Group 1	The system uses RF energy only for its internal function. Therefore, its RF emissions are very low and are not likely to cause any interference in nearby electronic equipment.
RF emissions CISPR 11	Class A	The system is suitable for use in all establishments other than domestic and those directly connected to the public low-voltage power supply network that supplies buildings used for domestic purposes.
Harmonic emissions IEC 61000-3-2	Class A	
Voltage fluctuations/ flicker emissions IEC 61000-3-3	In compliance	

# Electromagnetic Immunity

Table 49. Guidance and Manufacturer’s Declaration—Electromagnetic Immunity

The system is intended for use in the electromagnetic environment specified below. The customer or the user of the system should ensure that it is used in such an environment.

IMMUNITY TESTS	IEC 60601 TEST LEVEL	COMPLIANCE LEVEL	ELECTROMAGNETIC ENVIRONMENT – GUIDANCE
Electrostatic discharge (ESD) IEC 61000-4-2	± 8 kV contact ± 15 kV air	In compliance	Floors should be wood, concrete, or ceramic tile. If floors are covered with synthetic material, the relative humidity should be at least 30%.
Electrical fast transient/burst IEC 61000-4-4	± 2 kV for power supply lines 100 kHz repetition frequency	In compliance	Mains power quality should be that of a typical hospital environment.
Surge IEC 61000-4-5	± 1 kV line(s) to line(s) ± 2 kV line(s) to earth	In compliance	Mains power quality should be that of a typical hospital environment.
Voltage dips, short interruptions and voltage variations on power supply input lines IEC 61000-4-11	0% $U_T$ ; 0.5 Cycle At 0°, 45°, 90°, 135°, 180°, 225°, 270°, and 315° 0% $U_T$ ; 1 cycle and 70% $U_T$ ; 25/30 cycles Single Phase: at 0°	In compliance	Mains power quality should be that of a typical hospital environment. If the user of the system requires continued operation during power mains interruptions, it is recommended that the system be powered from an uninterruptible power supply or a battery.
Rated power frequency magnetic fields IEC 61000-4-8	30 A/m Frequency 50/60 Hz	In compliance	Power frequency magnetic fields should be at levels characteristic of a typical location in a typical hospital environment.
Conducted RF IEC 61000-4-6	3 Vrms 150 kHz to 80 MHz 6 Vrms in ISM bands 150 kHz to 80 MHz 80% AM at 1 kHz	In compliance	Portable and mobile RF communications equipment should be used no closer to any part of the system, including cables, than the recommended separation distance calculated from the equation applicable to the frequency of the transmitter. <b>Recommended separation distance d (m)</b> $d=1.2 \sqrt{P}$

Table 49. Guidance and Manufacturer’s Declaration—Electromagnetic Immunity

The system is intended for use in the electromagnetic environment specified below. The customer or the user of the system should ensure that it is used in such an environment.

IMMUNITY TESTS	IEC 60601 TEST LEVEL	COMPLIANCE LEVEL	ELECTROMAGNETIC ENVIRONMENT – GUIDANCE
Radiated RF IEC 61000-4-3	3 V/m 80 MHz to 2.7 GHz 80% AM at 1 kHz	In compliance	Interference may occur in the vicinity of equipment marked with the following symbol: 

Note:  $U_T$  is the AC mains voltage prior to application of the test level.

These guidelines may not apply in all situations. Electromagnetic propagation is affected by absorption and reflection from structures, objects and people.

## Accessory Conformance to Standards

To maintain electromagnetic interference (EMI) within certified limits, the system must be used with the cables, components, and accessories specified or supplied by Verathon. For additional information, see the [Components](#) and [Product Specifications](#) sections. The use of accessories or cables other than those specified or supplied may result in increased emissions or decreased immunity of the system.

Table 50. EMC Standards for Accessories

ACCESSORY	MAX LENGTH
Core QuickConnect Cable	1.57 m (5ft)
Core 2m QuickConnect Cable	2.03 m (6.7ft)
Core Smart Cable (Single-use system)	1.45 m (5ft)
Core Video Cable (Re-usable system)	1.57 m (5 ft)
Spectrum Smart Cable	1.6 m (5.2 ft)
Titanium Single-Use Smart Cable	1.6 m (5.2 ft)
Titanium Video Cable	2.2 m (7.2 ft)



# Glossary

The following table provides definitions for specialized terms used in this manual or on the product itself. For a full list of caution, warning, and informational symbols used on this and other Verathon products, please refer to the *Verathon Symbol Glossary* at [verathon.com/service-and-support/symbols](http://verathon.com/service-and-support/symbols).

TERM	DEFINITION
A	Ampere
AC	Alternating current
AER	Automated endoscope reprocessor
C	Celsius
CFR	Code of Federal Regulations (U.S.)
CISPR	International Special Committee on Radio Interference
cm	Centimeter
CSA	Canadian Standards Association
DC	Direct current
DL	Direct laryngoscopy
ED	Emergency Department
EMI	Electromagnetic interference
ESD	Electrostatic discharge
Essential performance	The system performance necessary to achieve freedom from unacceptable risk
ETT	Endotracheal tube
F	Fahrenheit
g	Gram
GHz	Gigahertz
HDMI	High-definition multimedia interface
hPa	Hectopascal
Hz	Hertz
ICU	Intensive Care Unit
IEC	International Electrotechnical Commission
in	Inch
ISM	Industrial, scientific, and medical
ISO	International Standards Organization.
kHz	Kilohertz
kPa	Kilopascal
kV	Kilovolt
L	Liter
m	Meter
mAh	Milliampere-hour

TERM	DEFINITION
MDD	Medical Device Directive
MHz	Megahertz
mm	Millimeter
NICU	Neonatal Intensive Care Unit
OR	Operating Room
OSHA	Occupational Safety and Health Administration (federal agency in U.S.)
oz	Ounce
Reprocessing	Preparing a reusable component for its next use. Reprocessing includes cleaning, disinfection, and sterilization as appropriate.
RF	Radio frequency
RH	Relative humidity
SDS	Sodium dodecyl sulphate
V	Volt
Vrms	Voltage root mean squared
W	Watt
WEEE	Waste electrical and electronic equipment



**verathon**